

# RV508

## REVERE GRANITE

Revere Granite sinks come in six colors to match any countertop: beige, black, mocha, silver, slate, and white. Molded from 80% quartzite and 20% acrylic, these sinks are naturally soundproof, scratch and stain-resistant, and can withstand temperatures up to 550 degrees.



## ACCESSORIES

- Basket Strainer:** S2
- Colored Strainer:** S3
- Colored Flange:** S4
- Grid:** GO-508

\*Accessories not included

## AVAILABLE COLORS





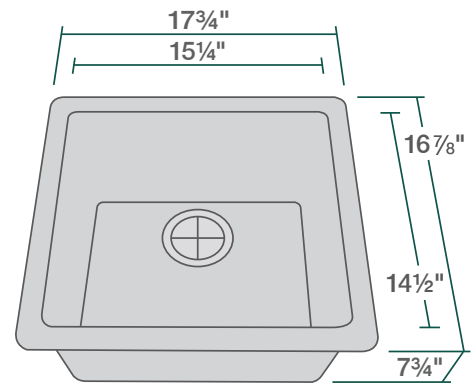







Dual-mount Installation  
 80% Quartzite and 20% Acrylic  
 All-Natural Materials  
 Eco Friendly & Recyclable  
 3 1/2" Offset Drain  
 Naturally Sound-Dampening  
 Cardboard Cutout Template Included  
 Installation Hardware Included  
 Lifetime Warranty

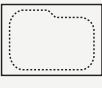

**Full Pallet Quantity: 28 Sinks**

## FEATURES

Dual-mount Installation 	18" Minimum Cabinet Size 	80% Quartzite 20% Acrylic 	Installation Hardware Included 	Cutout Template 	Offset Drain 3 1/2" 
Limited Lifetime Warranty 	Heat Resistant to 550° 	Silver Ions Added 	Stain Resistant 	Scratch Resistant 	



**REVERE**  
 The Rock Solid Choice